



Type(s)
Project
Date
Notes

OVERVIEW

Luminaire

As a moving mirror luminaire, the Cyberlight LED leverages technology to achieve a variety of facets of modern lighting design, including high-speed pan & tilt movement, and the need to better hide lighting fixtures in permanent installations. Customers with existing mirror fixtures in the themed entertainment market and elsewhere can retrofit those products with Cyberlight LED for more energy-efficient operation and service. The 470 W Bright white LED engine and the high-quality optical system delivers 12,750 field lumens with 90+ CRI for superior color rendering capabilities. A full complement of features are onboard Cyberlight LED for creative design possibilities, including color mixing plus color wheel, dual rotating pattern wheels, zoom, focus, iris, prism, and diffusion.

Applications

- Themed environments
- Concerts
- Theatres of all sizes
- Film and television broadcast studios
- Churches and houses of worship
- Cruise Ship

Product Features

- Bright white LED engine
- 470 W engine producing 12,750 field lumens at greater than 90 CRI
- Fast pan and tilt with break resistant moving mirror including Whisper Home positional encoding
- High quality 8-lens optic system
- Versatile 10°–28.5° zoom
- CMY/CTO-Linear color mixing system
- Seven position plus open replaceable Color Wheel
- 16-blade iris for extremely tight beam effects
- Both light and heavy diffusions standard
- Two Rotating Gobo Wheels with seven interchangeable glass gobos on each
- Four facet rotating prism
- Designed to bring LED technology to existing Cyberlight installations

ORDERING INFORMATION

Cyberlight LED

Model	Description
CYBER-BLACK 2597A1101	Cyberlight LED, black with foam packaging

Color Options: Fixtures ship standard in black. White available by request.

Included Accessories: Fixture includes yoke to allow attachment of user supplied clamps, one (1) fixture power cord bare ends to powerCON® TRUE1® input, and a safety cable.

Accessories

Part Number	Description
2597A1020	Snoot with glare reducing grid
2597A1022	Enhanced Spill Blocker
2560B7009	Fixture Power Cord upgrade, 5-15 Edison to powerCON TRUE1, 15 A
2560B7005	Fixture Power Cord upgrade, Stage Pin to powerCON TRUE1, 20 A
2560B7006	Fixture Power Cord upgrade, L6-20 to powerCON TRUE1, 20 A
2560B7007	Fixture Power Cord upgrade, L5-20 to powerCON TRUE1, 20 A
67040007	MegaClaw™
55040014	Cheeseborough 2" Alloy 1/2 Coupler Truss Clamp
67040010	Mini-Claw™



PRODUCT SPECIFICATIONS

Source

LED Details	470 W
Max Field Lumens	12,750 lumens
Integrating Sphere Lumens	12,750 lumens
LPW	27.1
LED Life	50,000 hours
Native CCT	6000 K
Transferable Light Engine	Yes

Color

Color Mixing	Cyan, magenta, yellow, CTO-linear
Color Temperature	Variable down to 2400 K
Color Wheel	Seven (7) interchangeable dichroic chips plus open

Optical

Beam Angle Range	10° – 28.5°
Gate Size	30 mm (1.18 in)
Aperture Size	140 mm (5.5 in)
Pattern Projection	Two rotating and indexable wheels with seven (7) patterns plus open
Prism	Four facet rotating prism
Frost	Light and heavy diffusion standard
Iris	16-blade iris
Flicker Control/Hz Range	2.2 kHz or 17.6 kHz

Control

Input Method	DMX (5-pin) or Ethernet
Protocols	DMX via RS-485 Art-Net or sACN via Ethernet
Ethernet Pass-Thru	Passive Ethernet in and thru with and without power
Data Conversion	Patented data conversion system for Ethernet to DMX
Modes (Footprint)	Standard (40 channels)
RDM Functions	Yes
UI Type	Full color graphical UI with 6-button navigational control
Local Control	Yes
Dimming Performance	16-bit, DMX controlled

Electrical

Voltage Range	100–240 VAC, 50–60 Hz
Input Method	powerCON TRUE1 TOP
Wattage (Max)	700 W
Current (Max)	7.0 A @ 100 V
Inrush (First Half Cycle)	120 V: 27.6 A 240 V: 56.4 A
Fixtures per Circuit on Standard R20 Breaker	2 (link up to 1 fixture via Power Thru connector) Note: TRUE1 connector rated for 20 A (120 V / 60 Hz) and 16 A (240 V / 50 Hz)

Thermal

Ambient Operating Temp	-10°– 40°C (14°– 104°F)
Fan Mode	Linear fan control, Standard and Studio

Physical

Pan and Tilt Range	180° pan, 112° tilt
Max Pan/Tilt Speed	180° in 0.56 s / 112° in 0.53 s
Materials	Steel and aluminum frame with molded plastic covers
Color Options	Black, white by request
Mounting Options	Any orientation
IP Rating	IP20
Weight	38 kg (83.7 lb)
Included Accessories	powerCON TRUE1 to bare end fixture tail Dual hang height yoke Safety cable

Warranty

Fixture Warranty	Five (5) year for light engine Two (2) year for complete fixture
Warranty Details	etconnect.com/Support/Warranty.aspx

Regulatory & Compliance

Regulatory Standards	Listed to UL 1573 Certified to CSA STD. C22.2 No: 166 FCC 47 CFR Part 15 EAC KCC: KN32, KN35 Japan EMC: VCCI-CISPR 32
CE Compliance Declared to These Standards	Safety: EN 60598-1, EN 60598-2-17, EN 62031, EN 62471, EN 55032, EN 55035
Complies to the RoHS Directive	Yes

Safety

Safety	Minimum distance to illuminated surface = 1.0 m (3.3 ft) Minimum distance from fixture head to combustible materials = 0.1 m (0.33 ft)
--------	---

Note: All LED sources experience some lessening of light output and some color shift over time. LED output will vary with thermal conditions. Thermal conditions can be affected by ambient temperatures and orientation.

FEATURE DETAILS



Return of a favorite

Cyberlight LED reinvigorates the moving mirror toolset with modern innovation and all new value. In a world of moving head fixtures, the Cyberlight LED stands proud with its unique feature set that is irreplicable with other moving lights.

Hide and Go Seek

One of the most unique aspects of a moving mirror fixture is the small area that the light is emitted from. Unlike a moving head fixture which requires the moving head to hang down through the ceiling or be hung in open air, a mirrored fixture can sit behind scenery, facade, or ceilings with a relatively small hole for the light to come out, making it an indispensable tool for any location where moving lights are not part of the desired aesthetic.

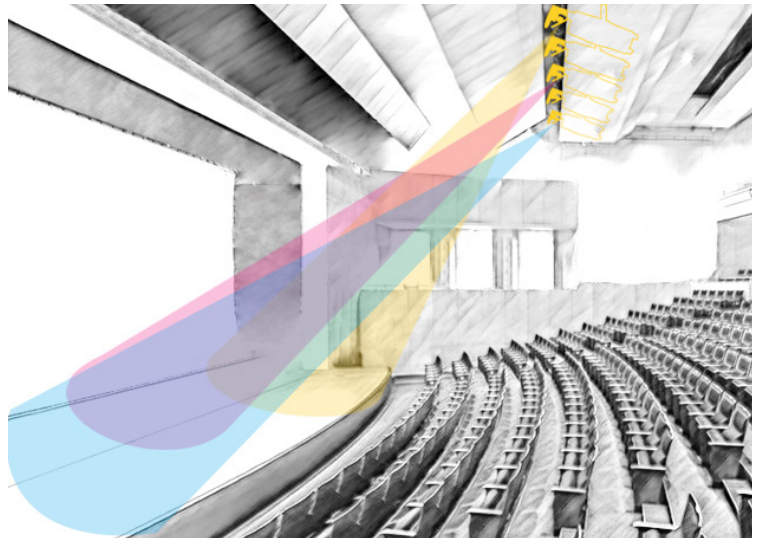



Pan and Tilt Precision

Like no moving mirror luminaire before, the Cyberlight LED utilizes absolute encoding and Whisper Home technology to ensure correct positioning at all times. Even during fast mirror moves, the Cyberlight LED can recognize its position, and correct its position without the hard reset that was required by mirror lights of days past.

FEATURE DETAILS

Rotating Gobo 1 Details

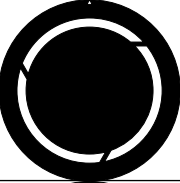
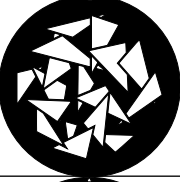
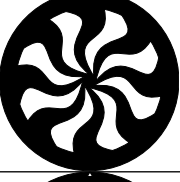
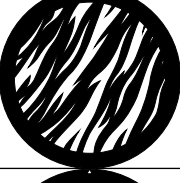
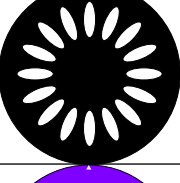
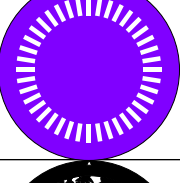
Outside Diameter	29.9 mm (1.18 in)
Image Diameter	25 mm (0.98 in)
Materials	0.5 mm aluminum 1.1 mm glass Borofloat® 2.9 mm Art Glass

	1 - TunnelD
	2 - Triangles
	3 - Sharpnado
	4 - Current-ly
	5 - Oval Tunnel
	6 - Indigo Chicklet
	7 - Jade Branches

Rotating Gobo 2 Details

Outside Diameter	29.9 mm (1.18 in)
Image Diameter	25 mm (0.98 in)
Materials	0.5 mm aluminum 1.1 mm glass Borofloat

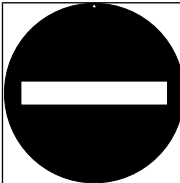
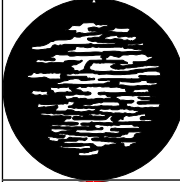
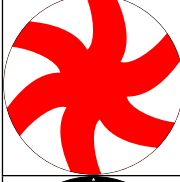
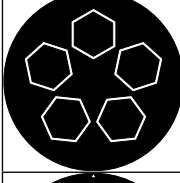
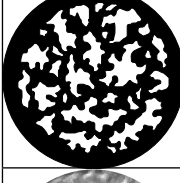
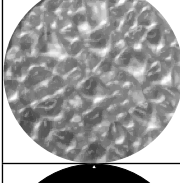
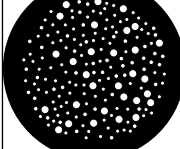
	1 - Bar
	2 - Interlocking Breakup
	3 - Technowedge
	4 - Starvolver
	5 - Organic
	6 - Ice
	7 - Shower

Color Wheel Details

Shape	Interchangeable wedge
Materials	1.11 mm glass Borofloat

	1 - Red
	2 - Blue
	3 - Green
	4 - Yellow
	5 - Orange
	6 - Purple
	7 - Dark Blue

PHOTOMETRIC DATA

Cyberlight LED

	Degree	Candela	Field Lumens	Power Usage	Lumens Per Watt
Narrow	10°	611,235	11,936	470 W	25
Wide	28.5°	84,640	12,759	470 W	27

Narrow - 10°

Throw Distance	10 ft 3.0 m	20 ft 6.1 m	30 ft 9.1 m	50 ft 15.2 m	200 ft 61 m
Field Diameter	1.75 ft 0.53 m	3.50 ft 1.07 m	5.25 ft 1.60 m	8.75 ft 2.67 m	35.0 ft 10.67 m
Illuminance (fc)	6,112	1,528	679	244	153
Illuminance (lux)	65,769	16,442	7,308	2,631	1,644

Wide - 28.5°

Throw Distance	10 ft 3.0 m	20 ft 6.1 m	30 ft 9.1 m	50 ft 15.2 m	200 ft 61 m
Field Diameter	5.1 ft 1.55 m	10.2 ft 3.10 m	15.2 ft 4.64 m	25.4 ft 7.74 m	101.6 ft 30.9 m
Illuminance (fc)	846	212	94	34	21
Illuminance (lux)	9,107	2,277	1,012	253	112

To determine center beam illumination in footcandles at any throw distance, divide candela by the throw distance squared.

Metric conversions: For meters, multiply feet by 0.3048.
For lux, multiply footcandles by 10.76.

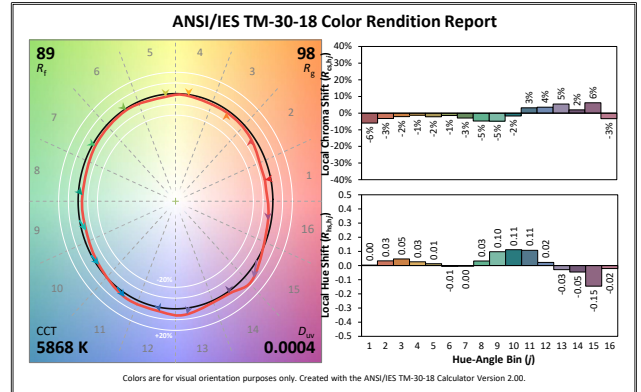

Additional Color Metrics	
CRI R _a (R _y)	92 (61)
TLCI	91

PHYSICAL INFORMATION

Cyberlight LED Dimensions

Model	Height		Width		Depth		Weight**	
	in	mm	in	mm	in	mm	lb	kg
Cyberlight LED*	45.2	1149	17.3	439	13.3	339	83	37.6
Cyberlight LED with foam packaging	50	1270	22	559	21	534	99	44.8

**Does not include mounting hardware

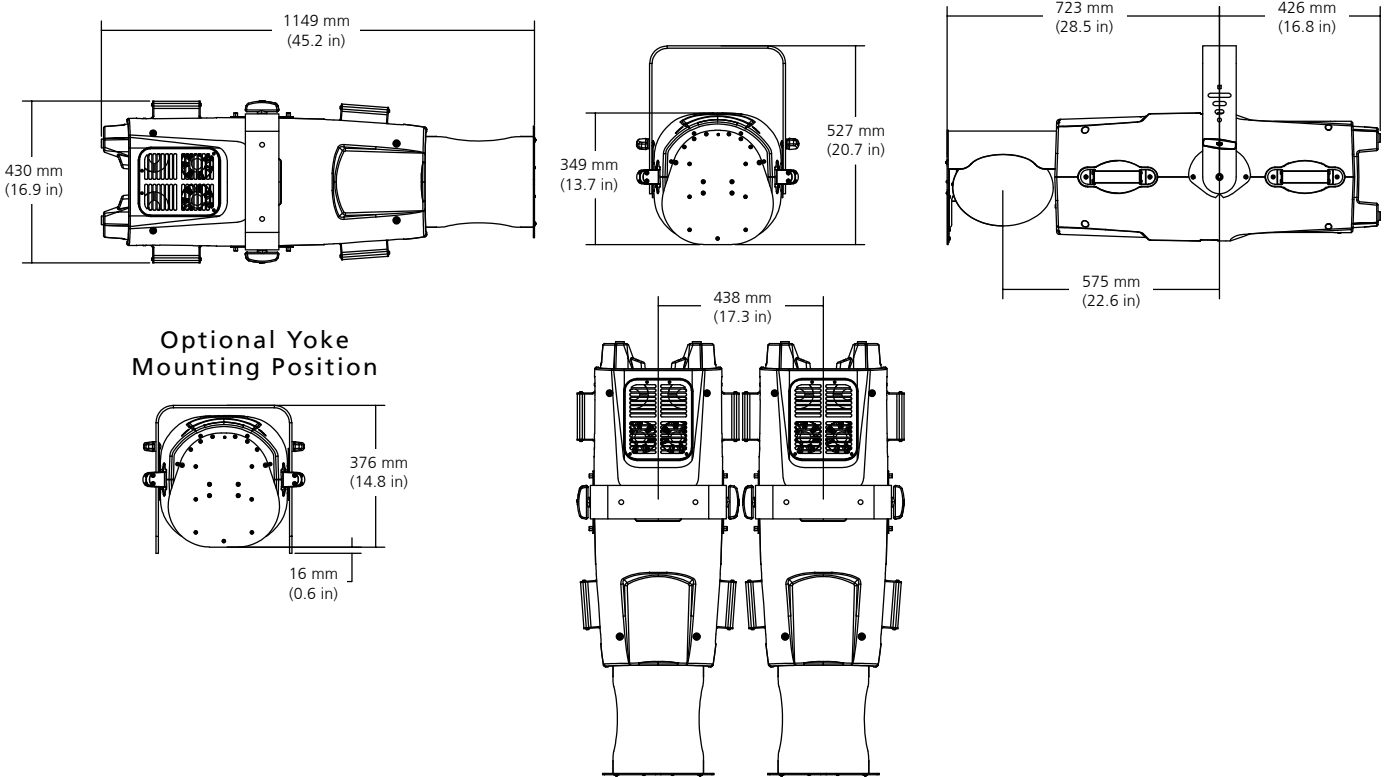

Power Table

VAC	Amps	Hz	Watts	VA	PF
100	7.0	50	694	697	0.99
120	5.7	60	681	687	0.99
200	3.3	50	661	666	0.99
208	3.2	60	661	666	0.99
220	3.0	50	661	669	0.99
230	2.9	50	656	661	0.99
240	2.8	60	659	667	0.98



Corporate Headquarters • Middleton, WI USA

Global Offices • London, UK • Rome, IT • Holzkirchen, DE • Paris, FR • Hong Kong
Dubai, UAE • Singapore • New York, NY • Orlando, FL • Los Angeles, CA • Austin, TX

Copyright©2022 ETC. All Rights Reserved. All product information and specifications subject to change. Rev B 2022-03

*Trademark and patent info: etconnect.com/IE

etconnect.com